



FRESH AIR. FRESH IDEAS. NO BOUNDARIES.

Designed with a 3/1 solar harvest to output power ratio for optimal battery recharging and autonomy. With a sleek and modern aesthetic, this powerful outdoor workstation is built to last and will upgrade any outdoor environment.

*The benches shown are the optional Custom Concrete Plaza benches.

OVERVIEW

- Highest solar power capacity of any charging station on the market
- True off-grid solar power design that delivers dependable year-round charging power, even in worst case weather conditions
- Charges 75-150 mobile devices per day (typical use)
- Supports mobile phones, tablets, laptops, cameras, and other portable devices
- Brilliant, non-glare LED lighting system for nighttime use
- Optimized system design includes high-quality UL listed solar power components for safe and trouble-free performance
- Architectural design with a fully engineered commercial grade structure
- Hardened for public use and low maintenance
- The structure has a minimum service life of 30 years
- ADA compliant design — seats four to eight comfortably



120 Volt and USB Outlets



Sleek, Modern Design



Attractive LED Lighting

BENEFITS

- Reduces carbon footprint
- A high visibility green symbol with tangible benefits for your community
- Complements a wide range of landscapes and architectural aesthetics
- Provides off-grid electronic device power in a convenient and attractive way
- Provides continuous electronic device charging even during extended grid power outages
- A green infrastructure problem solver for any outdoor public space; improves traffic flow and attracts positive interaction
- Connects users to the value of green power and your organization's concrete commitment to sustainability

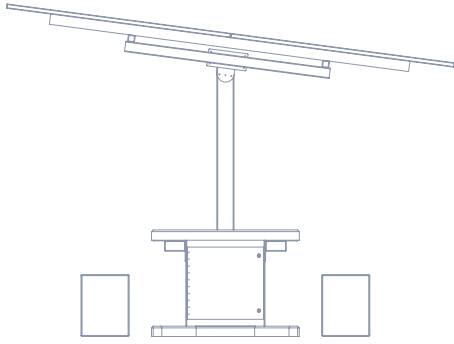

DIMENSIONS

- Canopy height (high side): 8'5"
- Canopy head clearance height (low side): 6'8"
- Bench seat size & footprint (1): 4'6" W x 1'2" L
- Table top: 4'6" W x 3'7" L
- Table footprint (base without benches): 4'6" W x 3'7" L
- Canopy: 6'7" W x 11'0" L

STRUCTURE

- 100% powder coated structural steel
 - ASTM A-500 Grade B structural steel: vertical tube and solar canopy supporting tube; thickness: 3/16
- Architectural cast concrete tabletop & benches
- Wind speed rating: 160 mph self-ballasted (no surface attachment required)
- Durable, industrial strength construction
- Stain resistant & easy to clean surfaces
- Seats four to eight comfortably with a minimum 24" centerline distance between parallel seats
- Total weight: 1,813 lbs (additional 400+lbs per bench)

SOLAR POWER SYSTEM

- Solar array capacity: 1kW DC
- Autonomy: three days
- Depth of discharge : 40%
- Four standard 120V AC receptacles
- Eight high-speed USB charging ports
- Battery bank: (2) 105 AGM valve regulated lead acid (VRLA)
- Battery bank voltage: 12V DC
- Battery replacement cycle: five years/1000 cycles (typical)
- Daily energy production 3,800Wh¹
- Inverter: Morningstar SureSine300
- Charge controller: Morningstar TS-MPPT-45 (maximum power point tracking)
- P.E. designed, NEC Section 250 code compliant, off-grid solar PV and user outlet power system

1. PV Array Daily Energy Production with average irradiance for Philadelphia, PA in June (with 1000 watt solar panel capacity)
2. Additional fixed power loads requires 2nd battery; additional loads can limit device charging power availability
3. Consultation with a tax advisor recommended.
4. http://www.dsireusa.org/incentives/incentive.cfm?Incentive_Code=US02F
5. http://www.dsireusa.org/incentives/incentive.cfm?Incentive_Code=US06F

MONITORING & METERING

- User monitoring/meter: Morningstar Remote Meter-2
 - Charge controller RM2 meter for access to current operating parameters
- Optional upgrade or retrofit charge controller kit with comprehensive system monitoring and control via ethernet port and Morningstar web portal

SECURITY

- Robust ballast mount system maximizes safety and stability
- Additional "anti-vandal" surface attachment options
- Robust, heavy gauge steel components; inherently vandal-proof
- Tamper resistant hardware and fasteners

WARRANTY

- One year warranty on installation
- Twenty-five year warranty on solar panel power output
- Individual component warranties

OPTIONS

- User logos, graphics or advertiser/sponsor branding
- Powered wi-fi access and security camera mounts/enclosures²
- Plug load monitoring system

- Ask us about quantity discounts
- Sunbolt qualifies for a 30% Federal Business Energy Investment Tax Credit (ITC) for tax paying individuals^{3,4}
- Sunbolt qualifies for Federal MACR accelerated depreciation for a tax paying business entity⁵
- Financing available



RECYCLED PLASTIC LUMBER BENCHES (STANDARD)

We've made sure that our standard bench is environmentally friendly by using a plastic lumber that is composed of recycled milk jugs. Available in a dark teal color.



CONCRETE LOBBY BENCH WITH IPE SEAT

An aesthetically pleasing bench option that incorporates a polished wood finish with smooth cast concrete supports. A perfect complement to the overall *Momentum* design.



CONCRETE PLAZA BENCH

A standard, smooth concrete bench option with an extended bench top. This bench blends seamlessly into the aesthetic of any property.



CUSTOM CONCRETE PLAZA BENCH







Our custom bench option, created specifically for the Sunbolt *Momentum*. This unique bench design is made of concrete with a smooth surface finish.

Steel Color Options

STANDARD RAL COLORS *(Don't see your color? Ask about custom finishes)*

			
RAL 7044 49/75480 - 38/70044	RAL 7036 49/72950 - 38/70036	RAL 7039 49/71020 - 38/70039	RAL 9017 49/80550 - 38/80017
			
RAL 9003 49/11400 - 38/10003	RAL 8028 49/66500 - 38/60028	RAL 6005 49/50670 - 38/50002	RAL 6020 49/52710 - 38/50020
			
RAL 5024 49/44660	RAL 5012 49/43170	RAL 5002 49/42220	RAL 5011 49/43180 - 38/40011
			
RAL 1015 49/15320 - 38/715015	RAL 1017 49/22510	RAL 3003 49/31100	RAL 3005 49/31900

PREMIUM COLORS *(Don't see your color? Ask about custom finishes)*

					
metallic 38/70044 Argento 312	metallic 38/90011 Argento 308	metallic 38/90009 Argento 307	metallic 38/90007 Argento 305	metallic 38/91020 Anodized Silver	metallic 38/15020 Champagne 303